

Operating instructions

(en)

Professional answering machine
with caller ID
and excellent recording quality

tiptel 309



tiptel

Contents

Contents	3
Safety notices	5
Controls	6
Assignment of keys	7
Service	9
Scope of delivery	9
Setting up	9
Connecting	9
Announcements	12
General	12
Examples of announcements	12
Recording an announcement	13
Checking announcements	14
Deleting announcements	14
Switching on and off	15
Playing back and deleting messages	17
Playing back new messages	17
Playing back all messages	17
Playing back specific messages	18
Replaying	18
Pausing playback	18
Search (Skip)	19
Deleting individual messages	19
Deleting all messages	19
Personal information (dictation)	20
Caller list	21
General	21
Browsing the caller list	21
Message function	23
Remote operation	24
Remote access	24
Remote operating functions	25
Switching on the device remotely	27

Settings	28
Setup options (functions)	28
Setup menu	29
Appendix	31
Service	31
Guarantee	31
CE sign	32
Ecological information	33
Troubleshooting.....	34
Default setting	35
Technical specifications	36
Index	37

Safety notices

Please observe the following notices very closely when setting up, connecting and operating the tiptel 309:

- Only connect the connection cables to sockets designated for this use.
- Install the connection cables in a safe manner. Connected cables must not be subjected to excessive mechanical stress.
- Set up the device far from electrical interference.
- Only connect accessories which are permitted with this device.
- Never open up the device yourself. Do not allow the plug contacts to touch sharp or metallic objects.
- Only clean the tiptel 309 with a soft, moist cloth. Do not use chemicals or abrasive cleaners.
- Protect the device from damp, dust, liquids and vapours.
- Do not expose the device to direct sunlight.
- Do not use the device in explosion-prone environments.
- Only use the original power supply unit and the original telephone connection cable.
- The wall socket that you use must be located close to this device and easy to access.

Controls

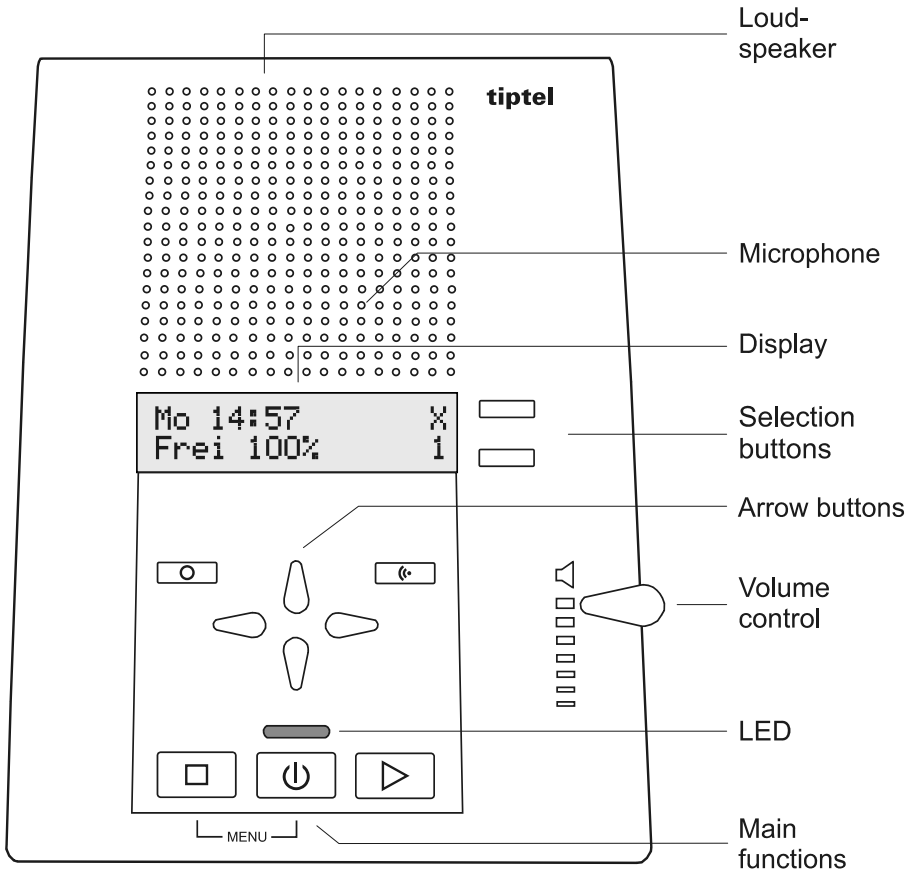

Assignment of keys



Playback: Starts the playback of new messages which you have not yet listened to. Press and hold "Playback" to repeat the last 3 seconds of the message.



2 secs

Playback pressed for 2 seconds: Starts playback of all messages. Playback will begin at the oldest message and will end with the newest one.

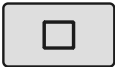

Stop: Stops the current function, also serves to confirm settings.



On/Off: Switches the answering machine's functions on or off.



Announcement: Press briefly to start playback of your current announcement. Press and hold to start recording a new announcement.



Record: Starts recording a dictation of personal information.



Control (up): Opens the list of messages and serves to navigate and set up in the setup menu.



Control (down): Opens the caller list and serves to navigate and set up in the setup menu.



Control (left): Moves the cursor to the left. Press during playback to repeat the current message. Press twice in quick succession to switch to the previous message during playback.



Control (right): Moves the cursor to the right. Press during playback to skip to the next message.

Assignment of keys



Select: Press this key to select input fields and functions which appear in the display next to the corresponding key.

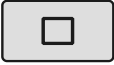

and



Stop and **On/Off** pressed at the same time: Opens the setup menu.

Service

Scope of delivery

Included in the packaging of your tiptel 309 are:

- tiptel 309
- Connection cables
- Adaptor (not in all countries)
- Power supply unit 5V / 1A / DC
- Operating instructions

Setting up

Your tiptel 309 has been manufactured for normal conditions of use. Solvents in furniture lacquers, wood oils and paint preservatives may corrode the bases of the device. Bases altered in this way may then leave stains on furniture.

Therefore always use a non-slipping base, especially with new or recently treated furniture.

Connecting

You must attach all necessary cables before you can start using your tiptel 309. The device offers two different connection options, depending on whether you are using a socket with several slots or just one.

- ☞ When you switch on the device for the first time, you will be invited to choose your language. Press the "Select" key until your language appears. Now press the "Stop" key to confirm your choice of language.

Socket with several slots

- 1 Plug the existing telephone into the socket (slot F).
- 2 Insert the power supply unit with the small connector into the "POWER" jack and then insert the power supply unit into a 230V wall socket.
- 3 Insert the TAE adaptor into a free end of the connection cable.
- 4 Insert the second free end of the connection cable into the "LINE" jack, and insert the TAE adaptor into the socket (slot N).

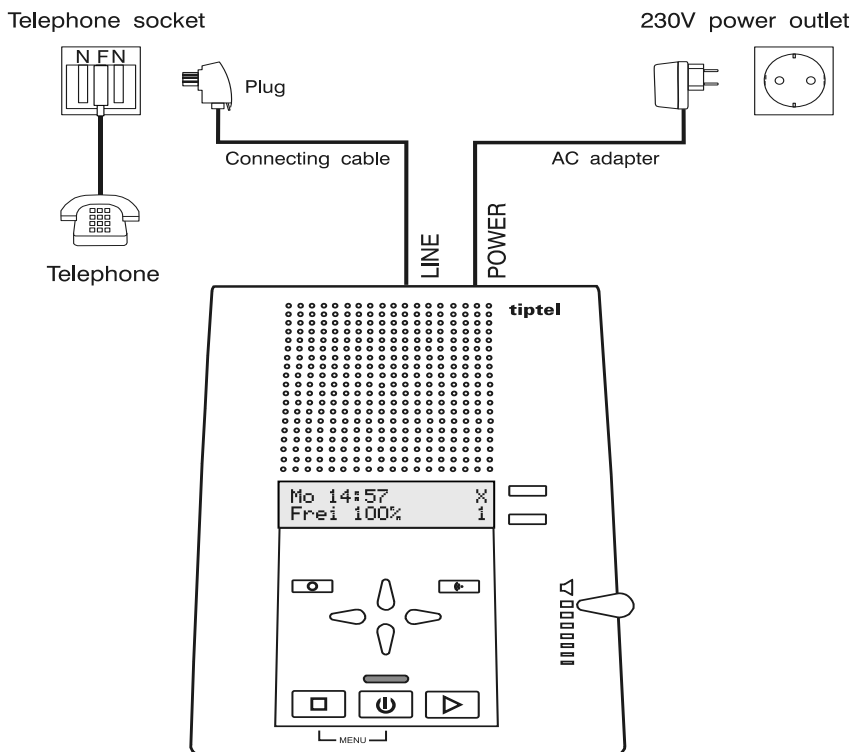

- ☞ In Austria, slot F corresponds to this symbol: ☎ and slot N corresponds to this symbol: △. Use the enclosed TST adaptor in place of the TAE adaptor.
- ☞ In Switzerland, a T+T83 A12 socket should be used, into which you should insert the enclosed T+T connection cable. If required, use an A6 adaptor in place of an A12 adaptor.

Socket with only one slot

- 1 Insert the power supply unit with the small connector into the "POWER" jack and then insert the power supply unit into a 230V wall socket.
- 2 Disconnect the existing telephone cable from the telephone and insert the freed-up connector into the "LINE" jack.
- 3 Insert the connection cable provided into the telephone with one connector and into the "TEL" jack with the other connector.

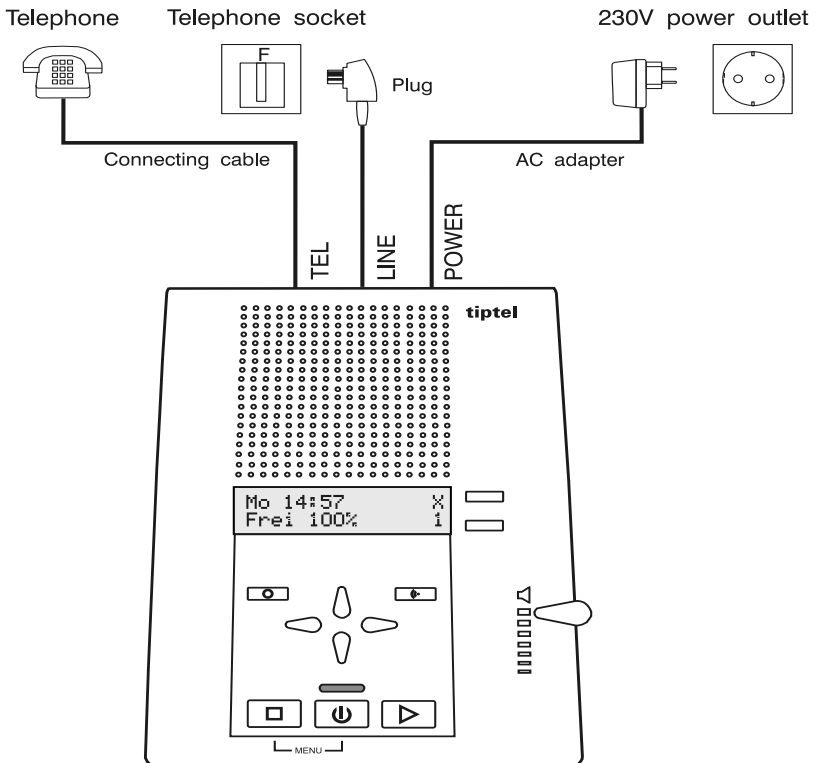

- ☞ This connection option is recommended on the assumption that the telephone's connections are a normal pair of telephone cable connections. This is the case if the telephone complies with Regulations TBR21 or ETSI ES 203 021. In the event that the "earth" and "alarm" contacts are used on your telephone socket, you must exclusively use a two-core telephone cable.

Announcements

General

Your tiptel 309 allows you to make two different announcements (announcement 1 & 2) and also has a built-in internal announcement (message 3). You can toggle between announcements using the lower "Select" key. Announcement 3 cannot be altered. An announcement can be between two seconds and three minutes long.

There are two different types of announcement: recordable and non-recordable announcements. With a recordable announcement, the caller can leave a message after hearing your announcement. With a non-recordable announcement, the caller is simply informed that you are unavailable and is not able to leave a message.

Examples of announcements

Recordable announcement

Hello, you've reached Manfred Müller in I'm out of the office at the moment and will be back at about ... You can reach me personally between ... and ... on [number]. Otherwise, simply leave your name and number and I will return your call. Please leave a message after the tone.

Non-recordable announcement

Hello, this is Willi Lohmann, sales representative for [company] in ... My office is temporarily closed due to staff sickness, for the holidays etc. Please call my colleague Mr. ... in ... on [number]. He will be able to assist you. Thank you for your call. Goodbye.

Recording an announcement

Recording 0:27
Announcement 1



Press "Select" to choose your desired announcement.

The announcement will appear at the bottom-right of the display.



Press and hold "Announcement".

Wait until you hear a short beep. Then "Recording.." will appear on the display.



Start speaking (speak into the microphone from a distance of about 15 cm).

The display will show how many minutes and seconds you have been speaking for.



To pause the recording, release the "Announcement" key.

"Recordable" and "Non-recordable" will appear on the display.

Answer mode.....
Answer only mode



To continue recording, press and hold "Announcement" once more.

Recording will continue.



To cancel the recording, press "Stop".

The recording will be deleted.



Use the "Select" key next to the corresponding line to choose whether you want the announcement to be recordable or not.

Recording is complete and the announcement will play again for you to check. You will hear one beep at the end of a recordable announcement. You will hear two beeps at the end of a non-recordable announcement.

- ☞ If you record announcement 2 as a non-recordable message, your tiptel 309 will automatically switch to this message if the recording memory is full.

Checking announcements



Playback 0:14 X
Announcement 1



Press "Select" to choose your desired announcement.

The announcement will appear at the bottom-right of the display.



Press "Announcement" **briefly**.

Your announcement will play back. The word "Playback", the time you have already listened to the message and the sequence number of the announcement will appear on the display.

You can set the volume by using the volume control.

Deleting announcements



Press the "Select" key next to the "delete" symbol during playback.

The current announcement will be deleted.

Switching on and off

- ☞ Make sure there is enough recording memory available. You can delete all messages or individual ones, whichever the case may be.

Calls	07	X
Messages	05	1



Press "Select" to choose your desired announcement.

The announcement will appear at the bottom-right of the display.



To switch on: Press "On/Off".

The LED will light up. With a non-recordable announcement, two lines will appear, representing the number of messages. The number of calls you have received will flash while the answering machine is dealing with the call.

If the caller's phone number is known, the display will change and the caller's number will appear on it for the duration of the call.

You can set the volume by using the volume control.

You can then listen to incoming messages. You can lift the receiver at any time while the message is recording to speak directly to the person telephoning you. The LED will flash if there are any new messages.



To switch off: Press "On/Off" once more.

No further calls will be answered. The display will return to the default mode. The LED will flash for as long as there are messages which have not yet been listened to.

- ☞ If the recording memory is full, your tiptel 309 will automatically switch to announcement 2 if this is a non-recordable announcement. Otherwise, the device will automatically switch off and will not answer any further calls.

Playing back and deleting messages

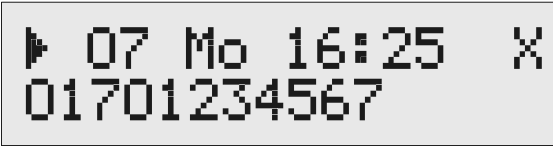

Playing back new messages



Press "Playback".

Playback of the new messages which you have not yet listened to will begin. The message's sequence number and the phone number of the caller of the current message will appear on the display. At the end of each message, you will hear the date and time that the call was made.

You can set the volume by using the slide control.

Playing back all messages



2 secs

Press "Playback" for 2 seconds.

Playback will begin at the first message.

Playing back specific messages

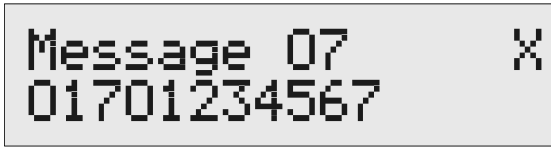

Press "Control" (up).

The list of messages will open.

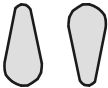

Search for the message that you want to play back with the "Control" keys (up/down).



To play back the chosen message: Press "Playback".

Playback will begin.

 You can also open the list of messages from the menu.

Replaying



Press "Playback" during playback.

The last 3 seconds will replay.

Pausing playback



Press "Stop".

Playback will be paused.



Press "Playback".

Playback will resume.

Search (Skip)



Press the "Control" left/right keys during playback.

The current message will stop and will replay or skip to the next one.

Deleting individual messages



Press the "Select" key next to the "delete" symbol during playback.

The current message will be deleted. All following messages will be automatically re-numbered and move up one place.

Deleting all messages

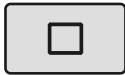

Press "Stop".

The display will show default or on-state mode.



Press the "Control" key next to the "delete" symbol for 2 seconds.

All messages will be deleted.

Personal information (dictation)

You can record your personal information into the in-built microphone. A recording must be at least 2 seconds long.



Press "Record".

Wait until you hear a short beep. Then "Recording" will appear on the display.



Start speaking (speak into the microphone from a distance of about 15 cm).

The display will show how many minutes and seconds you have been speaking for.



To end the recording, press "Stop".

Recording will finish. The LED will flash to indicate a new message. If the device was previously in on-state mode, the message counter will increase by one.



You can also record personal information in on-state mode. Other people can then access this information with the remote access code.

Caller list

General

The numbers of the last 30 incoming calls will be saved, specifying the day of the week and time of day that the call was received. If the caller's phone number was shown on the device during the call, this number will still be shown in the caller list. You are able to delete individual entries or the whole list.

Browsing the caller list



Press the "Control" (up) key.

The display will show the newest entry on the caller list.

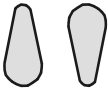

You can browse through the whole list using the "Control" (up/down) keys.

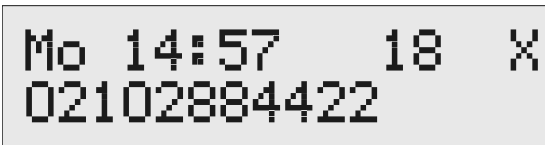

Press the "Select" key next to the "delete" symbol to delete an entry.

The entry will be deleted.

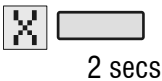

To delete the entire caller list, press the "Control" key next to the "delete" symbol for 2 seconds.

The entire caller list will be deleted.



To go out of the list, press "Stop".

The display will return to the original state.

- ☞ If the name of the caller is shown, you can switch to the phone number (and back again) by pressing the "Select" key next to the caller's name.

Message function

The message function allows a caller who knows the message code to leave a message, even when your tiptel 309 is set to play a non-recordable announcement. When your tiptel 309 is set to play a recordable announcement, the message function gives the caller the possibility to skip past the announcement.

Instructions on how to configure your message code can be found in the "Settings" section.



Call your tiptel 309 from another phone.

You will hear the announcement.



Start input by pressing the star key.

The announcement will stop.



Enter the message code with the telephone keypad. If you make a mistake, you can go back using the star key, and start again.

An automated voice after each digit will confirm its recognition.



To accept the code that you have entered, press the hash key.

The device will then prompt you to speak. If an incorrect code is entered, your tiptel 309 will switch off immediately.



Leave your message and finally replace the receiver.



The telephone from which you use the message function must be set up for tone dialling (MFV).

Remote operation

You can operate you tiptel remotely from anywhere in the world using the numeric keys on a touch tone (MFV) telephone. To operate your tiptel 309 remotely, you will need your personal remote access code. Instructions on how to individually configure the remote access code can be found in the "Settings" section (p. 28).

Remote access



Call your tiptel 309 from another phone.

You will hear the current announcement.



Start input by pressing the star key.

The announcement will stop.



Enter the remote access code using the telephone keypad. If you make a mistake, you can go back using the star key, and start again.

An automated voice after each digit will confirm its recognition.



To accept the code that you have entered, press the hash key.

When the correct code is entered, a voice prompt on your tiptel 309 will confirm this. If an incorrect code is entered, the device will disconnect.



Start your desired function by entering the corresponding digit.

If there are any new messages, playback will start automatically.



When you have finished your desired function, press "8".

The current function will end.



You can stop remote access by pressing the star key followed by the hash key.

- ☞ If 180 seconds have passed since the last key input, a voice on your tiptel 309 will say "please confirm", to check if you are still on the line. You must answer this confirmation request by pressing any key (e.g. **8**) within 8 seconds, otherwise the device will disconnect.

Remote operating functions

Message playback function

- | | | |
|---------------------|--|---|
| 3 | Play back all messages
Press "3". | Playback will begin at the first message. |
| 2 | Play back new messages
Press "2". | Playback of the new messages which you have not yet listened to will begin. |
| 5 ▷ | Replay
Press "5" during playback
. | The last 3 seconds will replay. |
| 8 | Pause playback
Press "8". | Playback will be paused. |
| 5 | Continue playback
Press "5". | Playback will continue from the place where you paused (e.g. after a confirmation request). |
| 4 6 ▷ | Search (Skip)
During playback, press "4" to go back or "6" to go forwards. | The current message will stop and will replay or skip to the next one. |
| 7 ▷ | Delete current message
Press "7" during playback. | The current message will be deleted. |
| * 7 | Delete all messages
Press "*" then "7". | All messages will be deleted. |

Two-way communication function

- 1** **Room monitoring/Intercom**
Press "1".

The microphone will switch on, and you will hear the vicinity of the tiptel 309.
- 1** Press "1" once more.

The device will switch out of the room monitoring function. You will hear anyone present near the tiptel 309 over the loudspeaker.

Programme switching function

- 7** **Changing to another announcement**
- 1 ... 3** Press "7" then "1", "2" or "3", depending on which announcement you would like to switch to.

The announcement selected will play for you to check. The device will play this message for the next caller.

Altering your announcement

- 9** **Altering your announcement**
- 1 ... 2** Press "9" then "1" or "2", depending on which announcement you would like to change.

Your tiptel 309 will prompt you to speak.



Record the message.

- 8** For a recordable personalised message: Press "8" after you have finished speaking.

Your message will play back for you to check. At the end, you will hear one beep.

or

- #** For a non-recordable announcement: Press "#" after you have finished speaking.

Your message will play back for you to check. At the end, you will hear two beeps.

Switching off the device remotely



Switching off the device

Press "*" then "0".

Your tiptel 309 will disconnect and will not accept any further incoming calls.

Switching on the device remotely



Call your tiptel 309 from another phone.

After 50 seconds, you will hear a beep.



Enter the remote access code using the telephone keypad. Start your keypad entry with "*" and confirm it with "#".

Your message will play back for you to check. The device can now be operated remotely (e.g. to record a new announcement). After you leave remote operation mode, your tiptel 309 will be switched on and will accept incoming calls.

Settings

Setup options (functions)

- Messages** Opens the list of messages.
- Language** German, English, French, Italian or Dutch.
- Time** Here you can re-configure the time.
- Date** Here you can re-configure the date (day, month, year).
- Talking clock** Yes or No. If you choose "Yes", you will hear the date and time at the end of every message.
- Network clock** Yes or No. If your telephone network or telecommunications system broadcasts the time, you can incorporate this time into the internal clock (the year will not be saved and must be set manually).
- Message length** Between 1 and 5 minutes, or indefinite. Here you can limit the length of a caller's message.
- Listen live** Yes or No. You can decide whether or not you want to be able to hear messages as they are being recorded.
- Rings** Between 1 and 9 rings. Here you can set the number of times your tiptel 309 will ring before diverting the call to the answering machine.
- Remote access code** ... The remote access code is a 1 to 4-digit number from 0 to 9999. Switch off remote access by setting the code to " - ".

- Remote access** Yes or No. If you choose "Yes" and there are new messages, your tiptel 309 will answer a call after one ring (regardless of how many rings you have set it to). If there are no new messages, the device will only answer a call after the set amount of rings. So you will know if there are any new messages before the call is even answered. That's why remote access is worth the effort.
- Message code** The message code is a 1 to 4-digit number from 0 to 9999. Switch off the message function by setting the code to " - ".
- Contrast**..... The display has 15 contrast levels.
- Basic setting** If you answer "Yes" to the confirmation message, the device will return to the default setting. All announcements and settings will be deleted.

Setup menu



and



Press "Stop" and "On/Off" together:

The setup menu will appear on the display.



Search for the desired setup option using the "Control" (up/down) keys.

All setting sub-sections will appear on the display.

Settings



Press the "Select" key next to the setting you would like to change until the desired setting appears on the display.

The display will show the current setting.

or



If you are required to enter digits, press the "Select" key next to the corresponding line.

The cursor will blink. Move the cursor a few times and the previous setting will be deactivated.

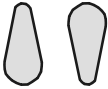

Change the setting using the "Control" (up/down) keys.

The display will count up or down.



With multi-digit settings, use the "Control" (left/right) key to move the cursor to the desired place.

The cursor will blink at the desired place.



To finish digit entry, press the "Select" key once more, next to the corresponding line.

The cursor will stop blinking.

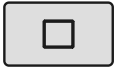

To finish inputting, press "Stop" several times.

The display will return to the original state.

Appendix

Service

You have purchased a modern product of TIPTTEL granting a continuous level of the highest quality. This is underlined by a certification according to DIN EN ISO 9001.

If, however, problems occur or you have questions on operating the device, please contact your local dealer.

Guarantee

Please contact your local dealer or importer for details of guarantee for non EC countries.

Within the European Community the following guarantee regulation applies:

Your contact for services arising from guarantee obligations is the authorised dealer where you bought the device.

TIPTTEL will grant a guarantee of 2 years from the date of handover for the material and for the manufacturing of the telecommunications terminal unit.

Initially, the purchaser shall have only the right of subsequent performance. Subsequent performance entails either repair or the supply of an alternative product. Exchanged devices or parts shall become the property of the authorised dealer.

If the subsequent performance fails, the purchaser can either demand a reduction in the purchase price or withdraw from the contract.

The purchaser shall notify the dealer immediately of any defects found. Proof of the guarantee entitlement shall be furnished by standard proof of purchase (receipt or invoice).

The guarantee entitlement shall expire if the purchaser or an unauthorised third party interferes with the device. Damage caused by inappropriate handling, operation, storage or by force majeure or other external influences shall not be covered by the guarantee.

The guarantee shall not cover any consumable material (e.g. batteries) or defects that only slightly impair the value or the usability of the device.

Claims for damage caused by transport shall be asserted to the delivery company.

Notes on settlement:

Repairs can only be conducted by the TIPTEL Service. A warranty repair does not prolong the warranty period – neither for the replaced parts nor for the device. This guarantee is not transferable and shall expire if the device is sold on to another party. It shall also expire if the device is interfered with by third parties or if the serial number on the device has been removed or made illegible. There is a guarantee seal on the device. Please do not damage or remove this seal because otherwise, your guarantee will expire.

The General Terms and Conditions of TIPTEL, which are part of the contract for a dealer, shall also apply. In the event of a complaint, the defective product shall be sent to the relevant TIPTEL subsidiary, the importer or dealer along with a description of the defect and the proof of purchase.

CE sign

This device is approved for the connection and use within the analogue public telephone networks in all EC countries – according to the European Requirements. Due to technical deviations in individual countries, we cannot grant an unlimited guarantee for the successful operation at all types of telephone accesses.

TIPTEL hereby declares that the device complies with all fundamental requirements of the European directive 1999/5/EC. This conformity is confirmed by the CE sign on the device.

Further details on the declaration of conformity can be found under the following internet address: <http://www.tiptel.com>

Ecological information

During the normal use of the telephone you will not have any contact to substances damaging to your health. The device is not battery-operated. The plastics used for manufacturing this device exclusively consist of partially recycled granules. The packaging materials do not consist of plastics but of partially recycled cardboard and paper.

If you do not have further use of your TIPTEL device, TIPTEL will take back the device without any charge. The device will be properly taken to pieces for recycling.

Troubleshooting

The device cannot function during a power failure. The internal clock will pause. All other settings will however be saved, so when the power supply is restored the device's settings will remain just as they were before. All you have to do is reset the clock (see p. 28).

Please try first of all to narrow down the cause and rectify the problem with the aid of the following table.

Problem	Possible cause	Solution/recommendation
No display	The device is not plugged in.	Check all cables and plug connections. Perhaps try another wall socket.
Display too light or dark.	Contrast misaligned.	Set the contrast.
No tone	The volume is set to zero.	Turn the volume up.
announcement number flashing	No announcement recorded.	Record a announcement.
No calls are coming in	Device not switched on.	Switch on the device.
No answer with telecommunications systems	Telecommunications system has no signal.	Check the telecommunications system's programming.
Buzzing or other disturbance during playback	Interference from e.g. cordless telephones, monitors etc.	Change the installation location.
No incoming messages are recording	The device is set to a non-recordable announcement.	Change announcement setting or record a new one.
No incoming calls, connected telephone not working	Incorrect connection cable, sockets incorrectly wired.	Only use original cables to check that the sockets are working (you may wish to call in a technician).

No caller ID with incoming call	Your network provider or telecommunications system does not support this function or the function is not activated. The caller has hidden his number or has an x-directory number. The call is from a public telephone.	Ask your network provider or telecommunications system manufacturer if the function is available or if it must be activated.
---------------------------------	---	--

Default setting

You will see the tiptel 309's factory settings in the following list. You can change these presets individually. You can return to the default setting at any time by going to the setup menu and selecting "basic setting".

Language	(E)
Talking clock	Yes
Network clock	No
Message length	2 mins
Listen live	Yes
Number of rings before diverting to answering machine	2
Remote access code	-
Remote access	No
Message code	-
Display contrast (middle)	8
Announcement	3 (fixed text)
On/off-state (when accepting calls)	Off

Technical specifications

Dimensions (W x H x D)	
tiptel 309	140 x 50 x 210 mm
Power supply unit	25 x 50 x 65 mm
Weight	
tiptel 309	350 g
Power supply unit	80 g
Operating voltage	
Power supply unit	100-240 V, 50/60 Hz
Power consumption in stand-by	less than 1 W
Ambient temperature	0 – 40 °C
announcements	
Number of announcements	3
Length of announcement	2 secs - 3 mins
Messages	
Recording technique	A-Law 88,2 kBit/s
Sampling frequency	11,025 kHz
Number of messages	99 (max)
Total recording memory	40 mins (approx)
Clip	
Caller ID	Dual mode DTMF/FSK
Caller list	30 entries
Data retention after power failure	> 10 years
Clock	Quartz clock
Display	Alphanumeric LCD 2 x 16 characters, light-up

Index

A

Assignment of keys..... 7

B

Basic setting 29

Browsing the caller list 21

C

Caller ID 15, 17

Caller list 21

CE sign 32

Checking announcements..... 14

Confirmation request 25

Connecting..... 9

Connection cables 9

Connection options..... 9

Contrast 29

Controls..... 6

D

Date..... 28

Default setting 35

Deleting all messages..... 19

Deleting announcements..... 14

Deleting during remote
operation 25

Deleting individual
messages 19

E

Ecological information 33

Examples of
announcements 12

G

Guarantee 31

L

Language..... 28

Listen live 28

M

Message code..... 23, 29

Message function 23

Message length 28

N

Network clock..... 28

Non-recordable
announcement 12

P

Packaging..... 9

Packaging materials 33

Pausing playback 18

Personal information..... 20

Playing back all messages... 17

Playing back new
messages 17

Playing back specific
messages 18

Power failure 34

Power supply unit 5, 9

R

Recordable announcement.. 12

Recording a non-recordable
announcement 26

Recording a recordable
announcement 26

Recording an
announcement 13

Remote access..... 24, 29

Remote access code 24, 28

Remote operating functions. 25

Remote operation..... 24

Replaying..... 18

Rings 28

Room monitoring..... 26

S

Safety notices 5
Scope of delivery 9
Search (Skip) 19, 25
Service 31
Setting up 5, 9
Setup options 28
Switching off 15

Switching on 15
Switching on remotely 27

T

TAE adaptor 9
Talking clock 28
Technical specifications 36
Time 28
Troubleshooting 34



Quick reference guide

Overview of functions

- ① Room monitoring / Intercom
- ② Playing back new messages
- ③ Playing back all messages
- ④ Searching (skipping) back
- ⑤ Repeating / continuing
- ⑥ Searching (skipping) forwards
- ⑦ Changing your announcement
- ⑧ Stopping / pausing playback
- ⑨ Altering your announcement
- * ⑦ Deleting
- * ⑩ Answering mode off

--	--	--	--

Personal remote query code

Remote access



Call the device and wait for the start of the announcement.



Press the star key.



Enter the remote query code using the telephone keypad.



To accept the code that you have entered, press the hash key.



Start your desired function by entering the corresponding digit.



To exit the function, press key 8.



You can stop remote access by pressing the star key followed by the hash key.



Quick reference guide

Overview of functions

- ① Room monitoring / Intercom
- ② Playing back new messages
- ③ Playing back all messages
- ④ Searching (skipping) back
- ⑤ Repeating / continuing
- ⑥ Searching (skipping) forwards
- ⑦ Changing your announcement
- ⑧ Stopping / pausing playback
- ⑨ Altering your announcement
- * ⑦ Deleting
- * ⑩ Answering mode off

--	--	--	--

Personal remote query code

Remote access



Call the device and wait for the start of the announcement.



Press the star key.



Enter the remote query code using the telephone keypad.



To accept the code that you have entered, press the hash key.



Start your desired function by entering the corresponding digit.



To exit the function, press key 8.



You can stop remote access by pressing the star key followed by the hash key.



Quick reference guide

Overview of functions

- ① Room monitoring / Intercom
- ② Playing back new messages
- ③ Playing back all messages
- ④ Searching (skipping) back
- ⑤ Repeating / continuing
- ⑥ Searching (skipping) forwards
- ⑦ Changing your announcement
- ⑧ Stopping / pausing playback
- ⑨ Altering your announcement
- * ⑦ Deleting
- * ① Answering mode off

--	--	--	--

Personal remote query code

Remote access



Call the device and wait for the start of the announcement.



Press the star key.



Enter the remote query code using the telephone keypad.



To accept the code that you have entered, press the hash key.



Start your desired function by entering the corresponding digit.



To exit the function, press key 8.



You can stop remote access by pressing the star key followed by the hash key.



Quick reference guide

Overview of functions

- ① Room monitoring / Intercom
- ② Playing back new messages
- ③ Playing back all messages
- ④ Searching (skipping) back
- ⑤ Repeating / continuing
- ⑥ Searching (skipping) forwards
- ⑦ Changing your announcement
- ⑧ Stopping / pausing playback
- ⑨ Altering your announcement
- * ⑦ Deleting
- * ① Answering mode off

--	--	--	--

Personal remote query code

Remote access



Call the device and wait for the start of the announcement.



Press the star key.



Enter the remote query code using the telephone keypad.



To accept the code that you have entered, press the hash key.



Start your desired function by entering the corresponding digit.



To exit the function, press key 8.



You can stop remote access by pressing the star key followed by the hash key.

Tiptel.com GmbH Business Solutions

Halskestraße 1

D - 40880 Ratingen

Tel.: 0900 100 – 84 78 35*

Vanity Tel.: 0900 100 – TIPTEL*

Internet: www.tiptel.de

International:

Internet: www.tiptel.com

*(1.49 euros/min. from Deutsche Telekom landlines, varying mobile network charges possible)

Tiptel GmbH

Ricoweg 30/B1

A - 2351 Wiener Neudorf

Tel.: 02236/677 464-0

Fax: 02236/677 464-22

E-mail: office@tiptel.at

Internet: www.tiptel.at

Tiptel AG

Bahnstrasse 46

CH - 8105 Regensdorf

Tel.: 044 - 843 13 13

Fax: 044 - 843 13 23

E-mail: tiptel@tiptel-online.ch

Internet: www.tiptel-online.ch

Tiptel B.V.

Camerastraat 2

NL – 1322 BC Almere

Telefoon: 036 – 53 666 50

Fax: 036 – 53 678 81

E-mail: info@tiptel.nl

Internet: www.tiptel.nl

Tiptel NV

Leuvensesteenweg 510 bus 4

B – 1930 Zaventem

Telefoon: 0903 99 333 (1.12 euro / min.)

Fax: 02 714 93 34

E-mail: tech@tiptel.be

Internet: www.tiptel.be

Tiptel sarl

23, avenue René Duguay-Trouin

F – 78960 Voisins-Le-Bretonneux

Tél. : 01 / 39 44 63 30

Fax : 01 / 30 57 00 29

e-mail : support@tiptel.fr

Internet : www.tiptel.fr



(en) 12/2011
EDV 4932870